

IEC Appliance Inlet C14 with Fuseholder 1- or 2-pole and Voltage Selector



IEC connector C14 with fuse holder 1- or 2-pole
 Screw-on mounting
 from front side



IEC connector C14 with fuse holder 1- or 2-pole
 with voltage selector
 Snap-in mounting from front side



See below:
[Approvals and Compliances](#)

Description

- Panel mount :
 Screw-on version from front or rear side, snap-in version front side
- 3 Functions :
 Appliance Inlet Protection class I , Fuseholder with interchangeable fuse drawer for Fuse-links 5x20 mm or 6.3x32 mm 1- or 2-pole , with or without voltage selector (step switch)
- Meets the requirements of IEC 60335-1 for appliances in unattended use. This includes the enhanced requirements of glow wire tests acc. to IEC 60695-2-12 and -13.
- Quick connect terminals 4.8 x 0.8 mm

Characteristics

- Available with or without internal connections
- The fuse drawer "Fingergrip" can be removed by hand
- Suitable for use in equipment according to IEC/UL 62368-1

Other versions on request

- Fuse drawer with other voltage values
- For protection class II
- Variant with notch for V-Lock mating Cordsets

References

Alternative: version with line filter [KFC](#)

Weblinks

[pdf data sheet](#), [html datasheet](#), [General Product Information](#), [Approvals](#), [Distributor-Stock-Check](#), [Accessories](#), [Detailed request for product](#)

Newly available variants corresponding to V-Lock mating cordset. The connector is equipped with a notch intended for use with the latching cordset. The cord latching system prevents against accidental removal of the cordset.

Technical Data

Ratings IEC	10A / 250VAC; 50Hz	Appliance inlet/-outlet	C14 acc. to IEC 60320-1, UL 60320-1, CSA C22.2 no. 60320-1 (for cold conditions) pin-temperature 70 °C, 10A, Protection Class I
Ratings UL/CSA	10A / 250VAC; 60Hz	Fuseholder	1-/2-pole, Shocksafe category PC2 acc. to IEC 60127-6, for fuse-links 5 x 20 / 6.3 x 32 mm
Dielectric Strength	> 3 kVAC between L-N > 4 kVAC between L/N-PE (1 min/50Hz)	Rated Power Acceptance @ Ta 23 °C	5 x 20: 2.5W (1 pole)/ 2W (2-pole) per pole 6.3 x 32: 3.15W (1 pole)/ 2.5W (2-pole) per pole
Allowable Operation Temperature	-25 °C to 70 °C	Power Acceptance @ Ta > 23°C	Admissible power acceptance at higher ambient temperature see derating curves
IP-Protection	front side IP40 acc. to IEC 60529	Voltage Selector	optional, step, 2-4 digits
Protection against electric shock	Suitable for appliances with protection class I acc. to IEC 61140		
Terminal	Quick connect terminals 4.8 x 0.8 mm		
Panel Thickness S	Screw: max 8mm Mounting screw torque max 0.5Nm Snap-in: 1.5/2/2.5 mm		
Material: Housing	Thermoplastic, black, UL 94V-0		

Approvals and Compliances



Detailed information on product approvals, code requirements, usage instructions and detailed test conditions can be looked up in [Details about Approvals](#)

SCHURTER products are designed for use in industrial environments. They have approvals from independent testing bodies according to national and international standards. Products with specific characteristics and requirements such as required in the automotive sector according to IATF 16949, medical technology according to ISO 13485 or in the aerospace industry can be offered exclusively with customer-specific, individual agreements by SCHURTER.

Approvals





The approval mark is used by the testing authorities to certify compliance with the safety requirements placed on electronic products.

Approval Reference Type: KEC

Approval Logo	Certificates	Certification Body	Description
	VDE Approvals	VDE	Certificate Number: 40046766
	UL Approvals	UL	UR File Number: E93617
	CCC Approvals	CCC	CCC Certificate Number: 2010010204409773



Product standards

Product standards that are referenced

Organization	Design	Standard	Description
	Designed according to	IEC 60320-1	Appliance couplers for household and similar general purposes
	Designed according to	IEC 60127-6	Miniature fuses. Part 6. Fuse-holders for miniature fuse-links
	Designed according to	UL 60320-1	Standard for Attachment Plugs and Receptacles
	Designed according to	CSA C22.2 no. 60320-1	General Use Receptacles, Attachment Plugs, and Similar Wiring Devices









Application standards

Application standards where the product can be used

Organization	Design	Standard	Description
	Suitable for applications acc.	IEC/UL 62368-1	Audio/video, information and communication technology equipment - Part 1: Safety requirements
	Suitable for applications acc.	IEC 60601-1	Medical electrical equipment - Part 1: General requirements for basic safety and essential performance
	Suitable for applications acc.	IEC 60335-1	Safety of electrical appliances for household and similar purposes. Meets the requirements for appliances in unattended use. This includes the enhanced requirements of glow wire tests acc. to IEC 60695-2-11 or -12 & -13.

Compliances

The product complies with following Guide Lines

Identification	Details	Initiator	Description
	CE declaration of conformity	SCHURTER AG	The CE marking declares that the product complies with the applicable requirements laid down in the harmonisation of Community legislation on its affixing in accordance with EU Regulation 765/2008.
	UKCA declaration of conformity	SCHURTER AG	The UKCA marking declares that the product complies with the applicable requirements laid down in the British Amendment of Regulation (EC) 765/2008.
	RoHS	SCHURTER AG	Directive RoHS 2011/65/EU, Amendment (EU) 2015/863
	China RoHS	SCHURTER AG	The law SJ / T 11363-2006 (China RoHS) has been in force since 1 March 2007. It is similar to the EU directive RoHS.
	REACH	SCHURTER AG	On 1 June 2007, Regulation (EC) No 1907/2006 on the Registration, Evaluation, Authorization and Restriction of Chemicals 1 (abbreviated as "REACH") entered into force.
		SCHURTER AG	V-Lock system are based on a matching plug-dose combination. The connector is equipped with a notch intended for use with the latching cordset. The cord latching system prevents against accidental removal of the cordset.
	White Paper Glow wire test	SCHURTER AG	Meets the requirements of IEC 60335-1 for appliances in unattended use. This includes the enhanced requirements of glow wire tests acc. to IEC 60695-2-11 or -12 & -13.
	Medical Equipment	SCHURTER AG	Suitable for use in medical equipment according to IEC/UL 60601-1 (1 MOOP, 1 MOPP)

Dimensions [mm]

Screw-on mounting

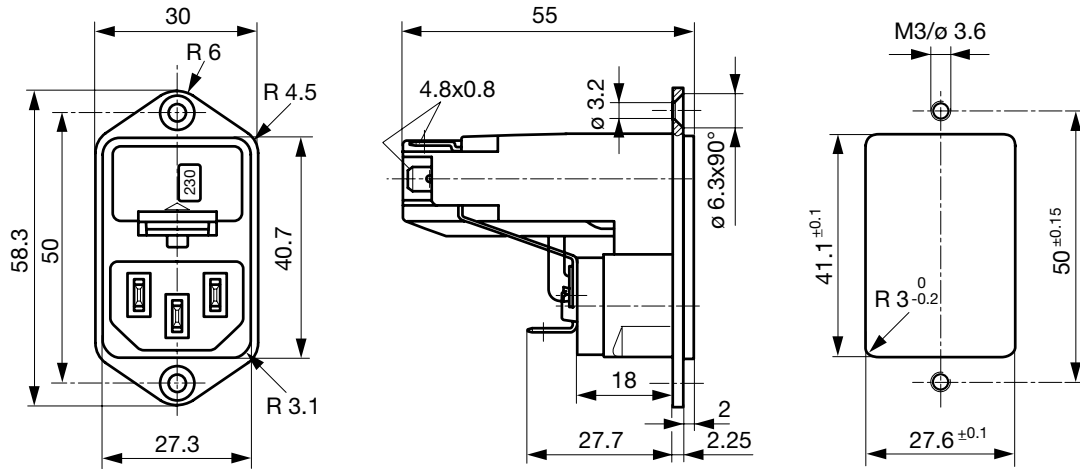

Snap-in mounting

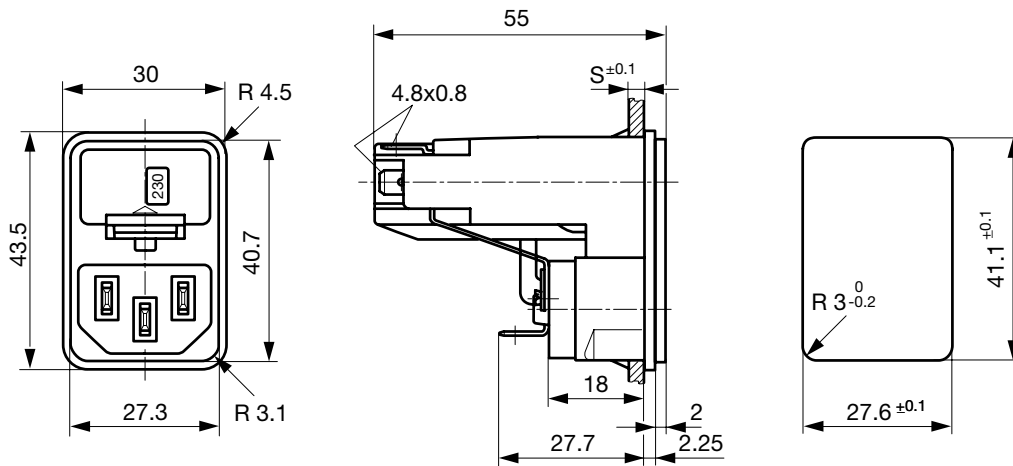

Diagrams

without conn.
 Voltage Selector
 4-positions, 1-pole

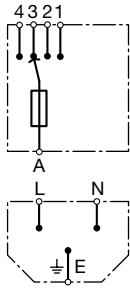

without conn.
 Voltage Selector
 4-positions, 2-pole

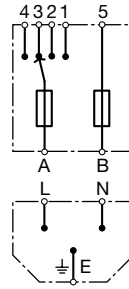

with internal connections
 Voltage Selector
 4-positions, 1-pole

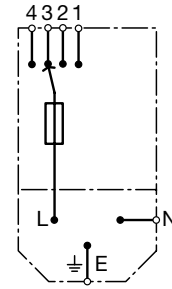

with internal connections
 Voltage Selector
 4-positions, 2-pole

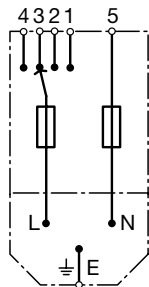

Voltage Selector
 3 pos.
 1-pole

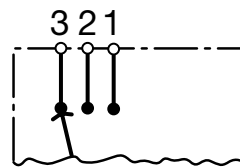

Voltage Selector
 3 pos.
 2-pole

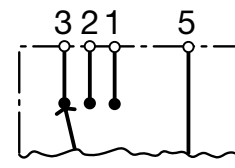

Voltage Selector
 2 pos.
 1-pole

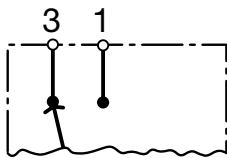

Voltage Selector
 2 pos.
 2-pole

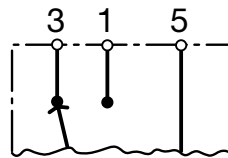

without voltage selector
 1-pole

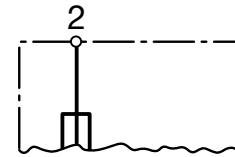

without voltage selector
 2-pole

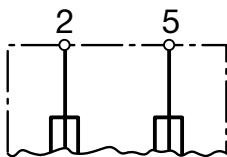

Derating Curves

Fuses
5 x 20 mm (1-pole)

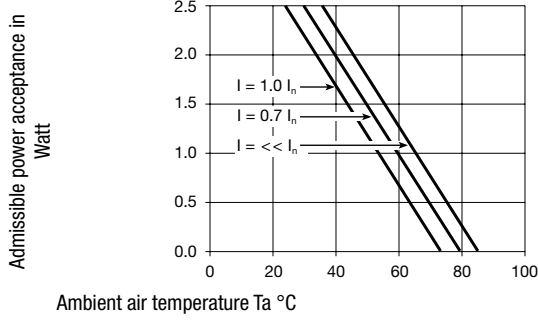

Fuses
5 x 20 mm (2-pole, per pole)

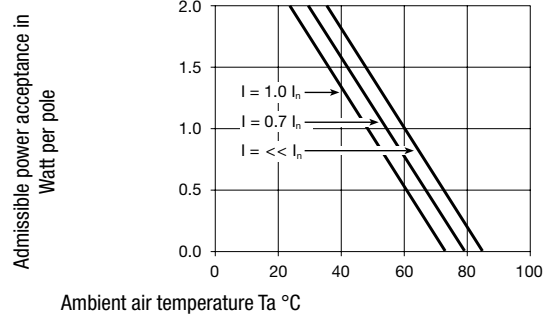

Fuses
6.3 x 32 mm (1-pole)

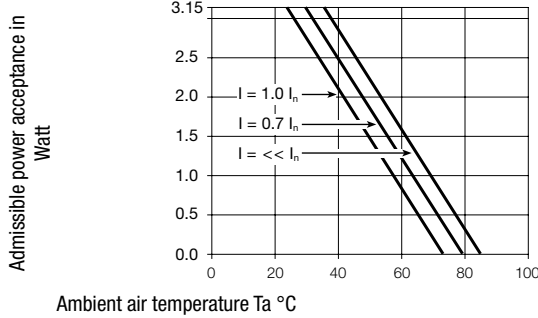

Fuses
6.3 x 32 mm (2-pole, per pole)

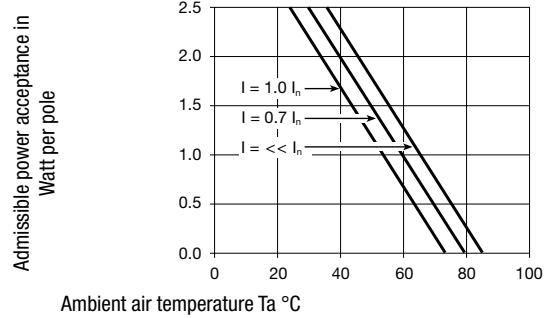

Variants

Panel mounting	Panel Thickness s [mm]	Fuseholder	Voltage Selector	Internally wired	V-Lock	Order Number
Snap-in	1.5	1-pole	-	●		4303.0032
Snap-in	1.5	1-pole	3/4 digits	●		4303.0092
Snap-in	1.5	1-pole	2 pos.	●		4303.0212
Snap-in	2	1-pole	-	●		4303.0033
Snap-in	2	1-pole	3/4 digits	●		4303.0093
Snap-in	2	1-pole	2 pos.	●		4303.0213
Snap-in	2.5	1-pole	-	●		4303.0034
Snap-in	2.5	1-pole	3/4 digits	●		4303.0094
Snap-in	2.5	1-pole	2 pos.	●		4303.0214
Snap-in	1.5	1-pole	-			4303.1032
Snap-in	1.5	1-pole	3/4 digits			4303.1092
Snap-in	1.5	1-pole	2 pos.			4303.1212
Snap-in	2	1-pole	-			4303.1033
Snap-in	2	1-pole	3/4 digits			4303.1093
Snap-in	2	1-pole	2 pos.			4303.1213
Snap-in	2.5	1-pole	-			4303.1034
Snap-in	2.5	1-pole	3/4 digits			4303.1094
Snap-in	2.5	1-pole	2 pos.			4303.1214
Snap-in	1.5	2-pole	-	●		4303.0002
Snap-in	1.5	2-pole	3/4 digits	●		4303.0062
Snap-in	1.5	2-pole	2 pos.	●		4303.0182
Snap-in	2	2-pole	-	●		4303.0003
Snap-in	2	2-pole	3/4 digits	●		4303.0063

Panel mounting	Panel Thickness s [mm]	Fuseholder	Voltage Selector	Internally wired	V-Lock	Order Number
Snap-in	2	2-pole	2 pos.	●		4303.0183
Snap-in	2.5	2-pole	-	●		4303.0004
Snap-in	2.5	2-pole	3/4 digits	●		4303.0064
Snap-in	2.5	2-pole	2 pos.	●		4303.0184
Snap-in	1.5	2-pole	-			4303.1002
Snap-in	1.5	2-pole	3/4 digits			4303.1062
Snap-in	1.5	2-pole	2 pos.			4303.1182
Snap-in	2	2-pole	-			4303.1003
Snap-in	2	2-pole	3/4 digits			4303.1063
Snap-in	2	2-pole	2 pos.			4303.1183
Snap-in	2.5	2-pole	-			4303.1004
Snap-in	2.5	2-pole	3/4 digits			4303.1064
Snap-in	2.5	2-pole	2 pos.			4303.1184
Screw	-	1-pole	-	●		4303.0031
Screw	-	1-pole	3/4 digits	●		4303.0091
Screw	-	1-pole	2 pos.	●		4303.0211
Screw	-	1-pole	-			4303.1031
Screw	-	1-pole	3/4 digits			4303.1091
Screw	-	1-pole	2 pos.			4303.1211
Screw	-	2-pole	-	●		4303.0001
Screw	-	2-pole	3/4 digits	●		4303.0061
Screw	-	2-pole	2 pos.	●		4303.0181
Screw	-	2-pole	-			4303.1001
Screw	-	2-pole	3/4 digits			4303.1061
Screw	-	2-pole	2 pos.			4303.1181

Availability for all products can be searched real-time: <https://www.schurter.com/en/info-center/support-tools/stock-check-distributors>

The fuse drawer is not included and must be ordered separately (see required accessory).

Packaging unit

50 Pcs

Required Accessory

Description

[Fusedrawer_3](#)

Fusedrawer for Fuse Links 5x20 mm resp. 6.3x32 mm



Fingergrip, 5 x 20, 2-pole, Voltage Selector	4303.2014.00
Fingergrip, 5 x 20, 2-pole, Voltage Selector, 100, 120, 220, 240	4303.2014.01
Fingergrip, 5 x 20, 2-pole, Voltage Selector, 110, 150, 220	4303.2014.02
Fingergrip, 5 x 20, 2-pole, Voltage Selector, 110, 220	4303.2014.03

...

Accessories



RC320
 Rear Cover for Power Entry Module



Cord_retaining_kits
 Cord retaining strain relief

Flat head, A	4700.0001
--------------	-----------

Mating Outlets/Connectors

Category / Description

[Appliance Outlet Overview complete](#)



4787, Mounting: Screw-on mounting, Appliance Outlet: IEC Solder terminals, 10 A, Suitable for appliances with protection class I	4787
IEC Appliance Outlet F or H, Screw-on Mounting, Front Side, Solder, PCB or Quick-connect Terminal	5091

[Connector Overview complete](#)



4782 Mounting: Power Cord, 3 x 1 mm ² / 3 x 18 AWG, Cable, Connector: IEC C13	4782
4785 Mounting: Power Cord, 3 x 1 mm ² / 3 x 18 AWG, Cable, Connector: IEC C13	4785
4300-06 Mounting: Power Cord, 3 x 1 mm ² / 3 x 18 AWG, Cable, Connector: IEC C13	4300-06
4781 Mounting: Power Cord, Cable, Connector: IEC C15	4781
4784 Mounting: Power Cord, 3 x 1 mm ² / 3 x 18 AWG, Cable, Connector: IEC C15	4784

Mating Outlets/Connectors shuttered



[Connector Overview complete](#)

4783 Mounting: Power Cord, 3 x 1 mm ² / 3 x 18 AWG, Cable, Connector: IEC C13	4783
--	------

[Power Cord Overview complete](#)



VAC13KS, Overview, V-Lock cord retaining, diverse Connector IEC C13, diverse, black	VAC13KS
VAC17KS, V-Lock cord retaining, diverse m, Connector IEC C17, diverse, black / grey / white	VAC17KS