

Heavy Duty Fuse Clip, 10.3 x 38 /10.3 x 85 mm, 1500 VAC/VDC, 32 A



Heavy duty fuse clip  
Solder THT terminal



Heavy duty fuse clip  
Screw or rivet terminal

1500 V · 32 A

See below:  
[Approvals and Compliances](#)

**Description**

- Solder/screw/rivet mounting
- For photovoltaic and other DC applications
- Suitable gPV fuse link ASO 10.3x38

**Unique Selling Proposition**

- Special copper alloy material for high efficiency
- Very low contact resistance
- Minimal power dissipation due to strong clamping force
- Ideal for use in high power applications like EV-charging

**Applications**

- Photovoltaic applications
- Inverters
- Battery charge controllers
- String fuse holder
- DC applications
- E-Mobility charging stations

**References**

Fuseholder to [ASO 10.3x38](#)

**Weblinks**

[pdf data sheet](#), [html datasheet](#), [General Product Information](#), [Distributor-Stock-Check](#), [Accessories](#), [Detailed request for product](#), [Microsite](#)

**Technical Data**

Fuse-Link	10.3 x 38 / 10.3 x 85 mm
Mounting	PCB
Terminal	Solder THT / screw / rivet
Rated Voltage	1500V
Rated current	32A
Admissible Ambient Temp.	-40°C to 155°C <sup>1)</sup>
Climatic Category	40/155/21 acc. to IEC 60068-1 <sup>1)</sup>
Material	Copper alloy, silver-plated / tin-plated <sup>1)</sup>
Storage Conditions	0°C to 60°C, max. 70% r.h.
Product Marking	 Type

Soldering Methods	Wave <a href="#">Soldering Profile</a>
Solderability	245°C / 3 sec acc. to IEC 60068-2-20, Test Ta, method 1
Resistance to Soldering Heat	260°C / 10 sec acc. to IEC 60068-2-20, Test Tb, method 1
Contact Resistance	≤ 1 mΩ at 100 mA
Resistance to Vibration	acc. to IEC 60068-2-6, test Fc

<sup>1)</sup> Details see table of variants

**Approvals and Compliances**

Detailed information on product approvals, code requirements, usage instructions and detailed test conditions can be looked up in [Details about Approvals](#)

SCHURTER products are designed for use in industrial environments. They have approvals from independent testing bodies according to national and international standards. Products with specific characteristics and requirements such as required in the automotive sector according to IATF 16949, medical technology according to ISO 13485 or in the aerospace industry can be offered exclusively with customer-specific, individual agreements by SCHURTER.



**Approvals**

The approval mark is used by the testing authorities to certify compliance with the safety requirements placed on electronic products. Approval Reference Type: CSO

Approval Logo	Certificates	Certification Body	Description
	<a href="#">UL Approvals</a>	UL	UR File Number: E39328

**Product standards**

Product standards that are referenced

Organization	Design	Standard	Description
	Designed according to	UL 4248-1	Industrial Control Equipment
	Designed according to	CSA C22.2 no. 4248.1	Industrial Control Equipment





**Application standards**

Application standards where the product can be used

Organization	Design	Standard	Description
	Suitable for applications acc.	IEC/UL 62368-1	Audio/video, information and communication technology equipment - Part 1: Safety requirements

**Compliances**

The product complies with following Guide Lines

Identification	Details	Initiator	Description
	<a href="#">CE declaration of conformity</a>	SCHURTER AG	The CE marking declares that the product complies with the applicable requirements laid down in the harmonisation of Community legislation on its affixing in accordance with EU Regulation 765/2008.
	<a href="#">UKCA declaration of conformity</a>	SCHURTER AG	The UKCA marking declares that the product complies with the applicable requirements laid down in the British Amendment of Regulation (EC) 765/2008.
	RoHS	SCHURTER AG	Directive RoHS 2011/65/EU, Amendment (EU) 2015/863
	China RoHS	SCHURTER AG	The law SJ / T 11363-2006 (China RoHS) has been in force since 1 March 2007. It is similar to the EU directive RoHS.
	REACH	SCHURTER AG	On 1 June 2007, Regulation (EC) No 1907/2006 on the Registration, Evaluation, Authorization and Restriction of Chemicals 1 (abbreviated as "REACH") entered into force.

**Dimension [mm]**

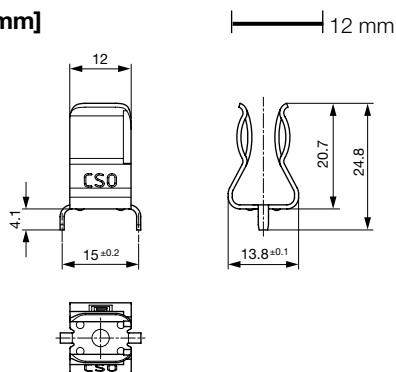

Solder, THT

Drilling diagram

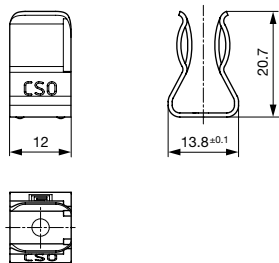
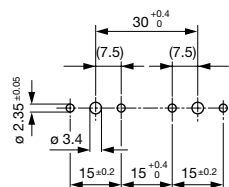

Screw or rivet version M3

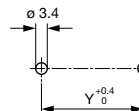

For fuse type 10.3 mm x 38 mm: Y= 30 mm  
 For fuse type 10.3 mm x 85 mm: Y= 77 mm

Drilling diagram



Screw or rivet version M5

For fuse type 10.3 mm x 38 mm: Y= 30 mm  
 For fuse type 10.3 mm x 85 mm: Y= 77 mm

Drilling diagram

### Derating Curves

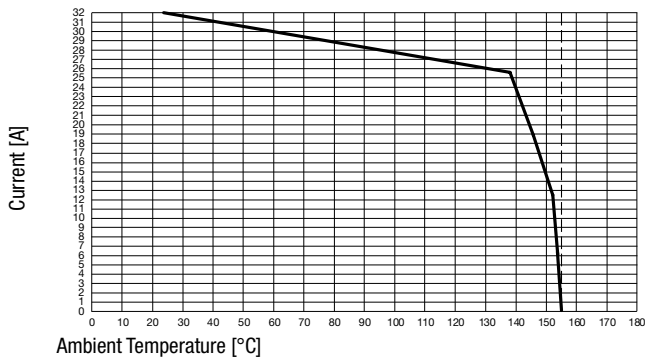

### Variants

Weight	Terminal	Packaging	Admissible Ambient Temp.	Climatic Category	Coating	Order Number
4.4 g	Screw / Rivet M5	Bulk 128 x 91 x 60 mm (100 pcs.)	-40 °C - 125 °C	40/125/21	Tin-plated	3-111-506
4.4 g	Screw / Rivet M5	Bulk 251 x 159 x 152 mm (1000 pcs.)	-40 °C - 125 °C	40/125/21	Tin-plated	3-111-507
4.4 g	Screw / Rivet M5	Bulk 128 x 91 x 60 mm (100 pcs.)	-40 °C - 155 °C	40/155/21	silver-plated	3-124-244
4.4 g	Screw / Rivet M5	Bulk 251 x 159 x 152 mm (1000 pcs.)	-40 °C - 155 °C	40/155/21	silver-plated	3-124-245
4.45 g	Screw / Rivet M3	Bulk 128 x 91 x 60 mm (100 pcs.)	-40 °C - 155 °C	40/155/21	silver-plated	0751.0500
4.45 g	Screw / Rivet M3	Bulk 251 x 159 x 152 mm (1000 pcs.)	-40 °C - 155 °C	40/155/21	silver-plated	0751.0501
4.45 g	Screw / Rivet M3	Bulk 128 x 91 x 60 mm (100 pcs.)	-40 °C - 125 °C	40/125/21	Tin-plated	0751.0502
4.45 g	Screw / Rivet M3	Bulk 251 x 159 x 152 mm (1000 pcs.)	-40 °C - 125 °C	40/125/21	Tin-plated	0751.0503
4.6 g	Solder / THT	Bulk 128 x 91 x 60 mm (100 pcs.)	-40 °C - 155 °C	40/155/21	silver-plated	0751.0505
4.6 g	Solder / THT	Bulk 251 x 159 x 152 mm (1000 pcs.)	-40 °C - 155 °C	40/155/21	silver-plated	0751.0506
4.6 g	Solder / THT	Bulk 128 x 91 x 60 mm (100 pcs.)	-40 °C - 125 °C	40/125/21	Tin-plated	0751.0507
4.6 g	Solder / THT	Bulk 251 x 159 x 152 mm (1000 pcs.)	-40 °C - 125 °C	40/125/21	Tin-plated	0751.0508

Availability for all products can be searched real-time: <https://www.schurter.com/en/info-center/support-tools/stock-check-distributors>

Accessories

Description



[ESO\\_10.3x38](#)  
 Fuse Inserter/Extractor with Cover Function for 10.3x38 mm Fuses in Clips

10.3 x 38 mm, IP20	0853.1250
10.3 x 38 mm, IP20	0853.1251